



**VERKSÖKARE**  
RUNDA VERK MED STENANKARE

**WERKSUCHER**  
RUNDE WERKE MIT STEINANKERN

	 LONGINES 118	 LONGINES 119	 ZENITH 12					
	 EBEL 59	 FELSA 4035						
	 EBEL 60	 ETA 2440	 ETERNA 1417	 FELSA 81	 FELSA 21/21N	 LIP R 104	 LIP R 100	
	 LONGINES 320	 OMEGA 580	 ROLEX 270	 ROLEX 280	 UNIVERSAL 106, 600			
	 AS 969	 CHAIKA 1600	 EBEL 67	 ETA 2410	 ETERNA 1418	 ETERNA 1419	 FELSA 291	
	 FELSA 372	 FELSA 4062	 FHF 57 SC	 HELVETIA 132 (21.600)	 HELVETIA 133 (18.000)	 MIDO 0617 P AUT	 RECORD 130 140	 RECORD 330
	 REVUE 89	 TISSOT 709	 FELSA 197, 281					
	 AS 1477/1513 AUT	 AS 1635 SC AUT	 EBEL 70 AUT	 FHF 180	 OMEGA 450 AUT	 TISSOT 740 AUT		
		 ETERNA 1401 AUT	 BIFORA 70	 DUROWE 260 SC				
	 AS 645	 AS 964 SC	 AS 1000	 AS 1001 SC	 AS 1537 SC	 AS 1632	 ASTER	
	 AV 39	 BIFORA 735 SC	 BUSER 150 SC	 CERTINA 17-10	 CERTINA 140	 CERTINA 220	 CERTINA 224	 EBEL 73 AUT
	 EBEL 75 SC	 EBEL 76 SC	 EBEL 77	 EBEL 78	 ESSOR	 ETA 441	 ETA 620	 ETA 1010



**VERKSÖKARE**  
RUNDA VERK MED STENANKARE

**WERKSUCHER**  
RUNDE WERKE MIT STEINANKERN

	 ETA 1070 SC	 ETA 1170, 1200 SC	 ETA 2360 SC	 ETA 2365 SC AUT	 ETA 2510	 ETERNA 440	 ETERNA 625	
	 ETERNA 1031	 ETERNA 1194 SC AUT	 ETERNA 1200 SC	 ETERNA 1405	 ETERNA 1435	 FELSA 146	 FELSA 171	 FELSA 233
	 FELSA 4020	 FELSA 4022	 FHF 32	 FHF 34	 FÖRSTER 70 72 SC	 HELVETIA 101	 LIP R 110 SC	 MELANO 111
	 MIDO 707 PC SC AUT CLD	 MST 429 SC	 PESEUX 80	 PESEUX 150	 RECORD 50, 60	 REVUE 49	 ROLEX 400	 ROLEX 420 AUT
	 ROLEX 1100	 SIGMA	 TISSOT 17.2	 TISSOT 17.2 R-21 SC AUT	 TISSOT 715 SC	 UNIVERSAL 245, 257	 UNIVERSAL 245 SC	
	 CYMA 470 SC AUT	 FHF 1146	 ZENITH 82					
	 EBEL 84 SC	 G.P. 88						
	 ALPINA 565	 ALPINA 566, 568 SC	 AM 380 AUT	 AM 624	 AS 457, 487	 AS 612	 AS 676	
	 AS 970	 AS 1156	 AS 1180 SC	 AS 1193	 AS 1240 SC	 AS 1393 SC AUT	 AS 1456 SC	 ASTER 19/4
	 A.V. 2	 A.V. 40	 A.V. 45 SC	 A.V. 262.110	 BAUER 875 SC	 BERGER	 BIFORA 81 SC	 BIFORA 84
	 BIFORA 85 85 SC	 BLANCPAIN 42	 BLANCPAIN 47	 BUREN L.N.	 BUREN 300	 BUREN 355, 356	 BUREN 875. 875 SC	 BUSER 15
	 BUSER 70, 72	 CERTINA 19-10	 CERTINA 19-25 SC	 CERTINA 19-30	 CERTINA 19-45 SC AUT	 CERTINA 19-55 SC AUT	 CERTINA 160	 CERTINA 270 270 SC



**VERKSÖKARE**  
RUNDA VERK MED STENANKARE

**WERKSUCHER**  
RUNDE WERKE MIT STEINANKERN

	<b>CORTEBERT 506</b>	<b>CORTEBERT 601, 609, 629, 657</b>	<b>CORTEBERT 601, 609, 629, 657</b>	<b>CORTEBERT 657</b>	<b>CYMA 182</b>	<b>CYMA 814 816</b>	<b>CYMA 836</b>	<b>DAMAS 71. 71 SC</b>
	<b>DERBY 40</b>	<b>DOXA 2</b>	<b>DUOWE 318</b>	<b>DUOWE 322 SC</b>	<b>DUOWE 335 SC</b>	<b>EBEL 85 S SC</b>	<b>EBEL 86</b>	<b>EBEL 87 SC</b>
	<b>EBEL 88</b>	<b>EBEL 89 SC</b>	<b>ELECTION 415. 415 SC</b>	<b>ELECTION 435</b>	<b>ENICAR 119, 120</b>	<b>ENICAR 830, 837 SC</b>	<b>ENICAR 832, 839</b>	<b>ESSOR</b>
	<b>ET 52</b>	<b>ET 39,301</b>	<b>ETA 361</b>	<b>ETA 500</b>	<b>ETA 505</b>	<b>ETA 790</b>	<b>ETA 980</b>	<b>ETA 1301 SC</b>
	<b>ETA 1311 SC</b>	<b>ETA 2325, 2335</b>	<b>ETERNA 675. 675 SC</b>	<b>ETERNA 1025</b>	<b>ETERNA 1434</b>	<b>F.E.B. 190</b>	<b>FEF 250</b>	<b>FEF 400 SC</b>
<b>FELSA 64</b>	<b>FELSA 95</b>	<b>FELSA 158, 220, 259</b>	<b>FELSA 352</b>	<b>FELSA 380, AUT</b>	<b>FELSA 720</b>	<b>FELSA 780</b>	<b>FHF 6</b>	
<b>FHF 63</b>	<b>FHF 64 SC</b>	<b>FHF 125, 126</b>	<b>FHF 170</b>	<b>FHF 189</b>	<b>FHF 206</b>	<b>F.M. 110</b>	<b>FRECO FREY C</b>	
<b>FÖRSTER 106</b>	<b>GLYCINE 80, 90</b>	<b>GRIESEL 64</b>	<b>GUBA 875. 875 SC</b>	<b>HELVETIA 90</b>	<b>HELVETIA 91</b>	<b>HELVETIA 900 SC</b>	<b>HELVETIA 901 SC</b>	
<b>HPP 203</b>	<b>HPP 210 SC</b>	<b>INVICTA</b>	<b>I.W.C. 84</b>	<b>I.W.C. 94</b>	<b>I.W.C. 96</b>	<b>JUDEX</b>	<b>JUDEX 41</b>	
<b>J.E.J. 41, 46</b>	<b>J.E.J. 52</b>	<b>KASPER 500</b>	<b>LANCO 10</b>	<b>LANCO 804 SC</b>	<b>LANCO 806</b>	<b>LANCO 816</b>	<b>LANCO 824 SC</b>	
<b>LANCO 859 SC CLD</b>	<b>LANCO 864 SC</b>	<b>LAPANOUSE 311</b>	<b>LAVINA 115 115 SC.</b>	<b>LEMANIA 4500</b>	<b>LIENGME 9, 10, 810</b>	<b>LONGINES 8.68 ABC.</b>	<b>8.68 ABC. SC</b>	
<b>LONGINES 8.68 N.</b>	<b>8.68 N. SC</b>	<b>LONGINES 8.68Z</b>	<b>LONGINES 19.4</b>	<b>MATTER</b>	<b>MARVIN 300</b>	<b>MARVIN 310. 310 SC</b>	<b>MARVIN 320</b>	



**VERKSÖKARE**  
RUNDA VERK MED STIFTANKARE

**WERKSUCHER**  
RUNDE WERKE MIT STIFTEN-ANKERN

	<b>MEYER&amp;SES FILS 61</b>	<b>MIDO 812 C</b>	<b>MOERIS</b>	<b>MOVADO 105</b>	<b>MOVADO 190 SC</b>	<b>MST 373 SC</b>	<b>MST 422</b>	
	<b>MST 423</b>	<b>O.M. 140. 140 SC</b>	<b>OMEGA 19.4</b>	<b>OMEGA 19.4 T2</b>	<b>OPTIMA 10</b>	<b>OSCO 67 SC</b>	<b>PESEUX 60. 60 SC</b>	<b>PESEUX 210, 212 SC</b>
	<b>PESEUX 220</b>	<b>PHENIX 89. 89 SC</b>	<b>PHENIX 98</b>	<b>PIERCE 861. 861 SC</b>	<b>RECORD 102, 103</b>	<b>102, 103 SC</b>	<b>RECORD 302 302 SC</b>	<b>RECORD STABILIS</b>
	<b>RECTA C</b>	<b>RECTA 16/12 816</b>	<b>REVUE 42/42SC</b>	<b>REVUE 78/78SC</b>	<b>REVUE 82 SC</b>	<b>ROLEX 500 510 SC</b>	<b>ROLEX 1120 AUT</b>	<b>ROLEX 1130 SC AUT</b>
<b>RUSSBACH- HANNI</b>	<b>SONCEBOZ 262</b>	<b>SOLVIL</b>	<b>SUZA</b>	<b>TISSOT 19.4-3</b>	<b>UNIVERSAL 258</b>	<b>UNIVERSAL 458. 458 SC</b>	<b>UNIVERSAL 800</b>	
<b>UNITAS 166</b>	<b>UNITAS 200</b>	<b>UNITAS 580</b>	<b>UNITAS 630</b>	<b>UNITAS 6360</b>	<b>UROFA 522</b>	<b>V.C. 194</b>	<b>V.C. 196</b>	
<b>VENUS 60, 81</b>	<b>VENUS 65</b>	<b>VENUS 149</b>	<b>VULCAIN 78 P</b>	<b>VULCAIN 406 SC REV</b>	<b>WYLER A.80</b>	<b>ZENITH NSI</b>	<b>ZENITH 88</b>	
<b>ZENITH 88.8</b>								
	<b>FELSA 350</b>	<b>HPP 200</b>	<b>LONGINES 310</b>	<b>LONGINES 9.40</b>	<b>OMEGA 540</b>	<b>ZARIA SC 2009, 2009 A</b>		
	<b>AS 1320 SC AUT</b>	<b>EBEL 83 SC AUT</b>	<b>EBEL 94.95 SC AUT</b>	<b>ETA 1216 SC AUT</b>	<b>ETERNA 1319 AUT</b>	<b>FELSA 700 SC AUT</b>	<b>FHF 1146</b>	
<b>ROLEX 650</b>	<b>TUDOR 1410 SC AUT</b>							
	<b>ALPINA 762</b>	<b>AM 260</b>	<b>AM 290</b>	<b>AM 340</b>	<b>AM 380 AUT</b>	<b>AS 345</b>	<b>AS 1088</b>	



**VERKSÖKARE**

**RUNDA VERK MED STENANKARE**

**WERKSUCHER**

**RUNDE WERKE MIT STEINANKERN**

<p>9 3/4'''</p>	 A.V. 146.233	 BUREN 975	 BUREN LEP.	 BIFORA 91	 BIFORA 934. 934 SC	 CERTINA 133	 CERTINA 240
	 CORTEBERT 573	 CYMA 454	 DAMAS 61. 61 SC	 ESSOR S	 ETA 385	 ETA 530	 ETA 630
 ETA 825	 ETA 1306 SC AUT	 ETERNA 387	 ETERNA 845/905	 ETERNA 1033	 FELSA 90	 FELSA 145	 FELSA 186
 FHF 10	 FHF 28	 FRECO FREY 90 F	 GLYCINE 24	 GRUEN 179	 H.P. 61.63	 J.E.J. 41	 J.E.J. 217 217 SC
 JUDEX	 LANCO 922	 MARVIN 400	 MEYER&SES FILS 71	 M.S.T. 251	 MOERIS	 PESEUX 40	 PHENIX 250. 250 SC
 POLJOT 2209 SC	 RECORD STABILIS	 RECORD 160.170. 160.170 SC	 REVUE 50	 REVUE 79/79-SC	 ROLEX 600	 ROLEX 620 AUT	
 ROLEX 630 SC AUT	 ROLEX 635 AUT	 ROLEX 645 SC AUT	 SONCEBOZ 233	 TISSOT 21.7	 UNITAS 180, 185 SC	 UNIVERSAL 249	 UNIVERSAL 259
 VENUS 110, 113,	 WASA 115	 WOSTOK 2209 SC					
<p>10'''</p>	 I.W.C. 60 SC	 LEMANIA 4650 SC AUT	 LONGINES 10.86N	 PATEK 200 PHILIPPE			
	 LONGINES 10.26	 LONGINES 10.68 Z	 LONGINES 23 M	 LONGINES 23Z	 ROLEX 1200	 UNIVERSAL 330	 UNIVERSAL 332 SC
<p>10 1/2'''</p>	 A.H.O. 1021 SC	 1121 SC 1022 SC,CLD, 1125 SC AUT CLD 1132	 A.H.O. 1055	 AHS/LORD 152, 153 SC,CLD	 AHS/LORD 156 SC	 ALPINA 585	 ALPINA 586
	 AM 270, 277	 AM 280 425	 AM 440		 ANGELUS 56, 56 SC	 AROGNO 9	 AROGNO 60 260
<p>11 1/2'''</p>							



**VERKSÖKARE**  
**RUNDA VERK MED STENANKARE**

**WERKSUCHER**  
**RUNDE WERKE MIT STEINANKERN**

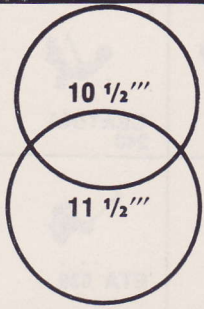

AROGNO 80	AROGNO 90	AROGNO 120.125	AROGNO 150	AROGNO 151	AROGNO 190 SC	AS 340	
AS 341	AS 415	AS 518	AS 635	AS 666	AS 922	AS 944	
AS 984 1002, 1120.	1123,1124. 1118 SC	AS 1049 AUT	AS 1125	AS 1131	AS 1158,1187 1194.1686 SC	AS 1171 AUT 1173 SC AUT	AS 1200 1201
AS 1205	AS 1215	AS 1220 SC	AS 1238	AS 1250 SC AUT	AS 1287 1294 SC	AS 1290 SC	
AS 1361 SC AUT	1395 SC AUT CLD	AS 1430 SC 1441 SC CLD	AS 1475 SC REV	AS 1506, 1507 SC	AS 1510 SC	AS 1525	AS 1530 SC
AS 1538 SC	AS 1580,1624 SC AUT	AS 1634	AS 1650	AS 1673 SC AUT	AS 1680 SC 1681 SC AUT CLD	AS 1690. 1691 CLD	AS 1700 SC AUT 1701 SC AUT CLD
AS 1702 SC 1703 SC CLD	AS 1704 SC 1705 SC CLD	ASTER	ASTER 23/7	A.V. 4	A.V. 42 420	A.V. 171 182 232	A.V. 423
BAUER alt	BENRUS B-25 (1296)	BERGER 30	BIFORA 102. 102 SC	BIFORA 103. 103 SC	BIFORA 104 SC	BIFORA 107. 107 SC CLD	BIFORA 111 SC AUT
BIFORA 113 SC	BULOVA 10 BM	BULOVA 11 AC	BUREN L.N.	BUREN 380	BUREN 410	BUREN 460	BUREN 480 SC
BUSER 25	BUSER 30, 36, 38	BUSER 101 SC	BUSER 315M SC	CERTINA 23-14 SC	CERTINA 23-20	CERTINA 23-35 SC	CERTINA 25-36 SC
CERTINA 25- 45 SCAUT	CERTINA 25-65 SCAUT	CERTINA 71	CERTINA 121 C	CERTINA 180, 185, 187.	180,185,187 SC	CERTINA 300 310.	300,310 SC
CERTINA 360 AUT	CERTINA 384 SC AUT	CERTINA 400	CERTINA 410 414 SC	CHEZARD 115	CHEZARD 7400	CORTEBERT 497	CORTEBERT 688,689 SC



**VERKSÖKARE**  
RUNDA VERK MED STENANKARE

**WERKSUCHER**  
RUNDE WERKE MIT STEINANKERN

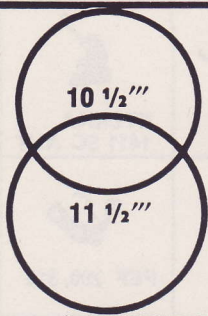

<b>CORTEBERT 697 SC</b>	<b>700 SC AUT</b>	<b>COURT 43. 43 SC</b>	<b>CRETIEZ</b>	<b>CULMINA 51,53</b>	<b>CULMINA 55 SC</b>	<b>CYMA 010 374</b>	
<b>CYMA 022</b>	<b>CYMA 030/032/376</b>	<b>CYMA 031/033</b>	<b>CYMA 162</b>	<b>CYMA 412,416 SC</b>	<b>CYMA 420 SC AUT</b>	<b>CYMA 455</b>	
<b>CYMA 458. 459 SC</b>	<b>DAMA 500. 520 SC</b>	<b>DAMAS 18 SC</b>	<b>DAMAS 51</b>	<b>DAMAS 512 SC</b>	<b>DODANE FC 8 SC</b>	<b>DODANE 344 SC</b>	<b>DOXA 14</b>
<b>DOXA 942</b>	<b>DUROWE F</b>	<b>DUROWE 410</b>	<b>DUROWE 422 SC</b>	<b>DUROWE 425,430 SC</b>	<b>DUROWE 440 SC</b>	<b>DUROWE 526</b>	<b>DUROWE 527</b>
<b>DUROWE 1032,1258 SC</b>	<b>1265, 1285, 1290 SC 1162,1269 SC,AUT, SC,AUT,</b>	<b>1035,1260, 1266 SC, CLD 1278,1772 SC,AUT,CLD</b>	<b>EBEL 93 SC AUT</b>	<b>EBEL 97</b>	<b>EBEL 99</b>	<b>EBEL 101 SC</b>	<b>EBEL 101.102 SC</b>
<b>EBEL 104 SC</b>	<b>EBEL 106</b>	<b>EBEL 111</b>	<b>EBEL 112</b>	<b>EBEL 113 SC AUT</b>	<b>114 SC AUT CLD</b>	<b>EBEL 115 SC</b>	<b>EBEL 116</b>
<b>EBEL 119 SC AUT</b>	<b>127 SC AUT RMA</b>	<b>EBEL 213 SC AUT</b>	<b>EBEL 214 SC AUT CLD</b>	<b>EBEL 313 SC AUT</b>	<b>EBEL 314 SC CLD</b>	<b>ECLY 1055</b>	<b>E.J. 46. 46 SC</b>
<b>ELECTION 62</b>	<b>ELECTION 605 SC AUT</b>	<b>ELECTION 625</b>	<b>ELECTION 645</b>	<b>ELECTION 665 SC</b>	<b>ENICAR 9</b>	<b>ENICAR 190 SC</b>	<b>ENICAR 410 SC</b>
<b>ENICAR 980 SC</b>	<b>ENICAR 1002</b>	<b>ENICAR 1012</b>	<b>ESSOR</b>	<b>ESSOR 45</b>	<b>E.T. 38</b>	<b>E.T. 40</b>	<b>E.T. 46</b>
<b>E.T. 50 SC</b>	<b>E.T. 51</b>	<b>ET 54 SC</b>	<b>E.T. 74.76</b>	<b>ETA 390</b>	<b>ETA 810, 818, 990 819 SC</b>	<b>ETA 900 926 SC</b>	<b>ETA 1051 SC</b>
<b>ETA 1061 SC</b>	<b>ETA 1080, 1081 SC</b>	<b>1147 SC 1093 SC,CLD</b>	<b>ETA 1152 SC</b>	<b>ETA 1256 SC AUT</b>	<b>1258 SC AUT CLD</b>	<b>ETA 1260, 1261</b>	<b>ETA 1280</b>
<b>ETA 2370 SC</b>	<b>ETA 2375 SC AUT</b>	<b>2377 SC AUT CLD</b>	<b>ETA 2390, 2391 SC</b>	<b>ETA 2450, 2451 SC AUT</b>	<b>2452, 2460 SC AUT CLD</b>	<b>ETERNA 175</b>	<b>ETERNA 600 600 SC</b>



**VERKSÖKARE**  
RUNDA VERK MED STENANKARE

**WERKSUCHER**  
RUNDE WERKE MIT STEINANKERN

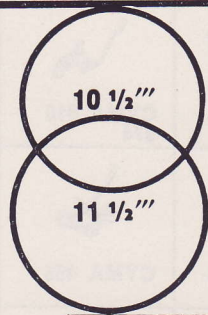

ETERNA 965/S 970/S	1020/S, SC	ETERNA 1078, 1079	ETERNA 1274, 1275	ETERNA 1406, 1407 SC	ETERNA 1408 SC	ETERNA 1411 SC AUT	
ETERNA 1421 AUT CLD	ETERNA 1436 SC AUT	ETERNA 1448 SC CLD	EXCELSIOR PARK 5	FEF 70 73, 103	FEF 190, 210, 222	FEF 290, 310	
FEF 330, 340 SC	FEF 350, 380 SC	FELSA 71, 80, 167, 184, 206.	FELSA 177	FELSA 294, 297, 300 SC	FELSA 279 AUT	FELSA 282 SC AUT	FELSA 335, 338, 367 SC
FELSA 383, 384	FELSA 400 SC	FELSA 410 AUT	415 SC AUT	FELSA 465 SC	FELSA 690 SC AUT	692 SC AUT CLD	FELSA 1560 SC AUT
FELSA 4000 SC AUT	FELSA 4010 SC	FHF 25 SC	FHF 28 SC	FHF 30, 31, 55, 76	FHF 55 SC	FHF 67 671 SC	FHF 70, 701
FHF 71, 711	FHF 72, SC 72-4 CLD	FHF 73 SC	FHF 74 SC	FHF 83	FHF 150, 152	FHF 175	FHF 183
FHF 185	FHF 186, 188	FHF 1146	FHF 1156	FRECO FREY A alt	FRECO FREY B	FÖRSTER 50 SC	80, 90 SC AUT 85 SC CLD 81, 91 SC AUT CLD
FÖRSTER 150 SC	FÖRSTER 500 SC	800 SC AUT	GLYCINE 72 SC	GP 08 SC AUT	GP 20 SC	GRUEN 315	GRUEN 460 AUT
GRUEN 415	GRUEN 705	GSW 70, 71 SC	GUBA 1050 AUT	GUBA 1100	GUBA 1200 SC AUT	HANHART 124, 126 SC	128 SC CLD
H.B. 105 SC	H.B. 106 SC	H.B. 110, 111 SC 112 113 SC CLD	H.B. 115, 120 1151, 1161 SC	HELVETIA 80, 82.	800, 820 SC	HELVETIA 81	HELVETIA 830 SC
HELVETIA 831	HELVETIA 836 SC AUT	HELVETIA 837 SC AUT	HELVETIA 838 SC AUT	HELVETIA 839 SC AUT	842 SC AUT CLD	HELVETIA 844 SC AUT CLD	845 SC AUT
H.P. 85. 85 SC	H.P. 90 SC 901 SC CLD	1901 SC AUT CLD	H.P.P. 412 SC	H.P.P. 601, 602 SC	603, 6031 SC CLD	H.S. P 62 SC	HS 236, 237



**VERKSÖKARE**

RUNDA VERK MED STENANKARE

**WERKSUCHER**

RUNDE WERKE MIT STEINANKERN

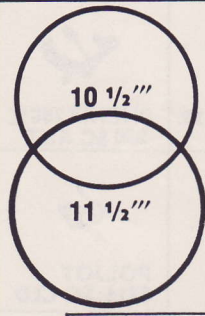

J.E.J. 23 SC	J.E.J. PS 31	JUNGHANS J 80	80/12 SC AUT	JUDEX 50 SC	JUDEX 120 B. 124 SC	JUNGHANS J 84, J 84/S SC	
JUNGHANS J 87	JUNGHANS J 93, 93S	93/1, 93/S 1 SC CLD	JUNGHANS J 93/S, S 10	KAISER 750, 800 SC	KAISER 900, 901 SC	KIENZLE 48 SC	
KUMMER 213	KUMMER 603	KURTZ 251, 25 SC	LANCO 1012, 1012, 1014 SC	LANCO 1020, 1021 SC	LANCO 1022	LANCO 1036	LANCO 1027, 1056 SC CLD
LANCO 1033 SC AUT	LANCO 1035	LANCO 1037 CLD	LANCO 1054 SC	LANCO 1064 SC	LANCO 1124	LANCO 1154 SC	LANDERON 4750
LAVINA 28	LAVINA 50, 120 SC	LAVINA 123	LAVINA 150 SC	LEMANIA 25.6, 27	25.6, 27 SC	LIENGME 23.46 SC	LIP R 23 SC
LIP R 25 SC	LIP R 103 SC	LIP R 105	LIP R 138	LOCARNO alt	LOCARNO neu	LONGINES 19A AUT	LONGINES 23 M
LONGINES 23 Z	LONGINES 280 SC	MARVIN 500 510	MARVIN 520 SC	MARVIN 540 S 565 SC	MARVIN 560 SC	MARVIN 580C SC AUT CLD	MARVIN 620/C CLD
MATTER 101	MAUTHE 610 SC	MAUTHE 612 SC	MELANO 102	MIDO 816 AUT	MIDO 00917 P SC AUT	MIDO 1002 A. SC	MINERVA 48
MOERIS C. C SC	MOVADO 115 AUT	MOVADO 150 MN	MOVADO 260 M SC	MOVADO 470	MST 202	MST 352, 352 SC	MST 371 SC
MST 410 AUT	MST 416 CLD	MST 420 SC AUT	MST 430 SC CLD	O.M. 115, 115 SC	OMEGA 23.7	OMEGA 23.7 T 3	OMEGA 220
OMEGA 570 SC AUT	OMEGA 470 SC AUT	OSCO 55, 56, 65, 66 SC	OSCO 100, 200 SC	201 SC CLD	OSCO 1060 SC	OTERO 28, 29 SC	
OTERO 40 SC 48 SC AUT	401 SC CLD 481 SC AUT CLD	OTERO 44, 45 SC	441 SC. CLD	OTERO 71 SC.	78 SC AUT 712 SC CLD 782 SC AUT CLD	PESEUX 170, 170 SC	PESEUX 180, 180 SC



**VERKSÖKARE**  
RUNDA VERK MED STENANKARE

**WERKSUCHER**  
RUNDE WERKE MIT STEINANKERN

		730,775 SC AUT 740 SC AUT CLD					
	782 SC CLD 783 SC AUT 784 SC AUT CLD						
				57/8 CLD 57/8 SC CLD 57/8 SC AUT CLD			
	130,131,132 SC						



**VERKSÖKARE**  
RUNDA VERK MED STENANKARE

**WERKSUCHER**  
RUNDE WERKE MIT STEINANKERN

					2522 P SC AUT 2522 C SC CLD 2522 PC SC AUT CLD			
	ZENITH NSI	ZENITH 106 alt	ZENITH 106. 106 SC	ZENITH 2511				
		ALPINA 592. 598 SC	AM 215	AM 225	AM 235	AM 250	AROGNO 54	
		AS 554	AS 1203	BUREN 462	CERTINA 320. 324 SC	CORTEBERT 677. 677 SC	CYMA 214. 444	
CYMA 215	DOXA 1	EBEL 120	EBEL 121 CLD	EBEL 123 SC	EBEL 129 SC CLD	EBEL 130 SC	EBEL 131 SC	
ELECTION 65	ENICAR 1150 SC	ENICAR 1152	ETA 1100 SC	ETA 1120. 1164 CLD	ETA 1168 SC	ETERNA 520. 520 SC		
ETERNA 833 SC AUT	834 AUT	ETERNA 1116 SC	1118 SC CLD	ETERNA 1136	FELSA 250	FELSA 253	FELSA 390. 395 SC	
FHF 26	FHF 27	FHF 50	FHF 1146	FHF 1146 SAV	GP 30	H.P.P. 420 SC AUT	421 SC AUT CLD	
I.W.C. 83	I.W.C. 88	JUNGHANS J 82. 82/1 SC	KUMMER 564	KUMMER 606	LANCO 1224	LANCO 1232 SC AUT	LANCO 1235 SC AUT CLD	
LANCO 1243 SC REV	LANCO 1264 SC	LEMANIA S.27 SC	LEMANIA 3600 AUT	LONGINES 12.68 Z	LONGINES 27 M. 27 MS SC	MIDO 917 P SC AUT	MIDO 1200 B SC AUT CLD	
MOVADO 220 SC AUT	MST 264	OMEGA 100	OMEGA 320 CHR	OMEGA 330 AUT	OMEGA 381 CLD	OMEGA 410		
OTERO 26, 30	26, 30 SC 30 SC CLD	P.U.W. 54,55 57,59,570 SC	590 SC AUT CLD	RECTA 1220	RECTA 1320	RECTA G	REVUE 59. 59 SC	

**VERKSÖKARE**

RUNDA VERK MED STENANKARE

**WERKSUCHER**

RUNDE WERKE MIT STEINANKERN

	 TISSOT 26.9-21 SC		 TISSOT 27, 27-3		 27 B-2 SC 27 B-21 SC 27 B-621 SC CLD			
	 TISSOT 27-4 CHR		 UNIVERSAL 262. 263 SC		 UNIVERSAL 267 SC		 UNIVERSAL 281 CHR	
 VULCAIN 120 SC REV	 VULCAIN 401 CLD REV		 ZENITH N.V.S.		 ZENITH 12-4		 ZENITH 40	
	 AS 1191 AUT		 AS 1298 SC AUT		 AS 1302 AUT		 EBEL 122 AUT	
	 OMEGA 360		 OMEGA 550 SC AUT		 OMEGA 590 SC AUT		 UNIVERSAL 138 AUT	
	 ALPINA 582 AUT		 BIFORA 120. 120 SC		 BIGALU 222. 222 SC		 BUREN 525 SC AUT	
	 CERTINA 28-15 SC		 CERTINA 28-45 SC AUT		 28-451 SC AUT CLD		 CYMA 464 REV	
 ETERNA 1247 AUT	 ETERNA 1428 SC AUT		 ETERNA 1438 AUT CLD		 JUNGHANS J 89 REV		 KIENZLE 57/19 SC AUT	
 RECORD 022-18	 ROLEX 1000. 1030 SC AUT		 1036, 1055 SC AUT CLD		 ROLEX 1530. 1560 SC AUT		 SEIKO SEIKOMATIC	
 TISSOT 28.1 AUT	 28.21 SC AUT		 TUDOR 390 SC AUT		 395 SC AUT CLD		 UNIVERSAL 128. 129 SC	
	 AROGNO		 AS 137		 AS 153		 AS 1130	
	 AS 1560. 1595 CLD		 AS 1590 AUT		 AS 1604. 1637 SC		 BUREN 3/0 S	
		 BUREN 210 CHR		 VENUS 170 CHR		 VENUS 230 SC REV		
		 AS 1162		 AS 1188		 BUSER 139		

**VERKSÖKARE**

RUNDA VERK MED STENANKARE

**WERKSUCHER**

RUNDE WERKE MIT STEINANKERN











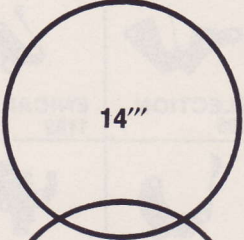
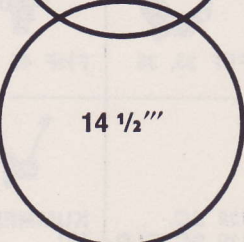















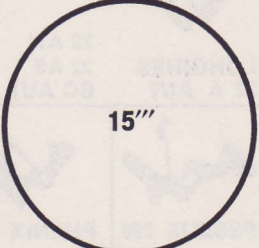
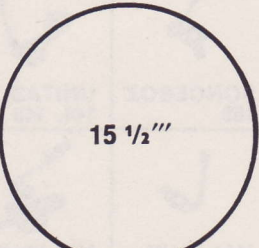











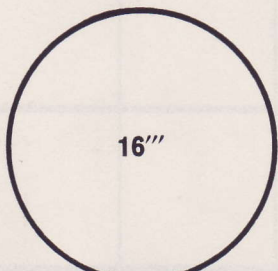

















	BUSER 182	CERTINA 330	CORTEBERT 485	DUROWE 630, 632 SC	ELECTION 805	ENICAR 1182	
	ENICAR 1290 SC	ETA 173	ETERNA 1159 SC AUT	ETERNA 1431,1433 SC	FEF 33, 35	FHF 46	
GP 03. 03 SC	HELVETIA 64	HPP 101	HPP 102, 103, 104	125,126 SC	HPP 107 CLD	128 SC. 129 SC CLD	KUMMER 161
LANCO 1	LANCO 1305 1336 CLD	LANCO 1357	LANDERON 13 CHR	LAVINA 105	LONGINES 13 ZN CHR	LONGINES 22 A AUT	22 AN 22 AS SC AUT
MARVIN 700. 700C CLD	MIDO 1117 PC SC AUT CLD	MOERIS C	MONTILIER 67	NIVADA 120 N	OMEGA 260	PESEUX 260	PHENIX 160
PIERCE 132 132 SC	PIERCE 135 SC REV	REVUE 38	REVUE 43	REVUE 80. 80 SC	REVUE 81 81 SC	SONCEBOZ 169	UNITAS 144. 146
UNITAS 176	UNITAS 640	UNITAS 6300 SC	UNITAS 6320	UNITAS 6340	VALJOUX 23 CHR	VALJOUX 90 SC CLD	VALJOUX 92 CHR
VENUS 140 CHR	ZENITH 133, 133.8 AUT 71 AUT CLD	ZENITH 135					
	FHF 65 SC AUT	LONGINES 30 CH CHR	MST 402				
	ETERNA 1115 U SC	ETERNA 1426 AUT CLD	HANHART 120 CHR	LANDERON 520	TIMEX 861 ELECTRIC		
	ENICAR 1292	FELSA 4100 SC	LANDERON 47 CHR	LANDERON 48 CHR	LANDERON 49 CHR	LANDERON 51 CHR	
	LANDERON 203	UNITAS 600					

**VERKSÖKARE**

RUNDA VERK MED STENANKARE

**WERKSUCHER**

RUNDE WERKE MIT STEINANKERN

 14'''  14 1/2'''	 BUSER 170	 CYMA 400 L CHR	 ETERNA 852	 ETA 853	 LANDERON 70 CHR	 VENUS 165 CHR	
	 VENUS 175 CHR	 VENUS 188 CHR	 VENUS 200 CHR CLD	 UNIVERSAL 285 CHR	 ZENITH 156 CHR		
	 LANDERON 15 CHR	 LANDERON 39 CHR	 LANDERON 52 CHR	 LANDERON 53 CHR	 LANDERON 501		
 15'''  15 1/2'''	 CYMA 505	 CYMA 564	 CYMA 565	 LANCO 1514 SC	 LONGINES 15.68 Z	 OMEGA 170 CHR	
	 REVUE 45	 TISSOT 33.3 CHR					
	 CYMA 571	 LANDERON 3 CHR	 LANDERON 4 CHR	 LANDERON 6, 7 CHR			
 16'''	 AS 611	 AS 1052	 AS 1058	 AS 1069	 BUSER 40	 CORTEBERT 620	
	 DOXA 4	 EBEL 18 B	 EBEL 21	 ENICAR 160	 ELECTION 57	 ELECTION 59	
 FELSA 125	 FELSA 160, 161	 FELSA 242	 FHF 35	 FHF 41	 FHF 45	 HELVETIA 49	 HELVETIA 51
 HELVETIA 52	 MARVIN 860	 MARVIN 890	 METODA DE LUXE	 MOLNIA 3602, 3602 A	 MOLNIA 3608 SC	 MONTILIER 63	 M.S.T. 240

**VERKSÖKARE**

RUNDA VERK MED STENANKARE

**WERKSUCHER**

RUNDE WERKE MIT STEINANKERN

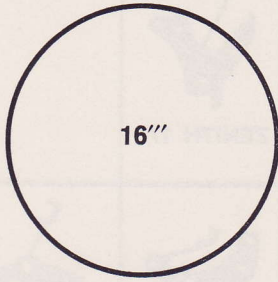

16'''

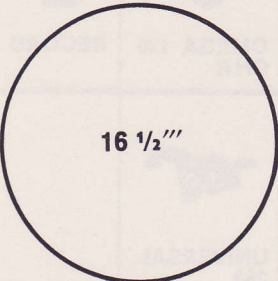

16 1/2'''

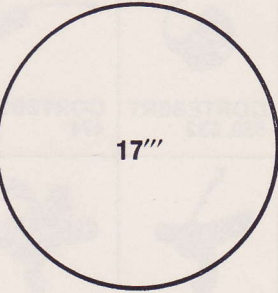

17'''

H.P. 22	RECORD 23,24	RECORD 25	RECORD 27	RECORD 204	SILVANA 1650		
VENUS 133	VENUS 173	VULCAIN 642	WYLER				
MARVIN 800	MARVIN 820	MARVIN 851	ROLEX 800				
ALPINA 327, 737	ALPINA 365	AM 520	AS 1063	ASTER 22/12	ASTER 38/35		
BLANCPAIN 51	BUREN 22	BUREN 368	CERTINA 260	CYMA 704	CYMA 705		
CYMA 750	CYMA 764	CYMA 765	DAMAS 23	DERBY 27	DOXA 16/12	DOXA 22/12 B	ETA 953
ETERNA 331	ETERNA 957 957 SC	FELSA 170	FHF 16	LONGINES 37.9	LONGINES 37.9 ABC	LONGINES 37.9 M	LONGINES 17.95 M
OMEGA 40.6	OMEGA 140	OMEGA 150	OMEGA 160	RECONVILIER 22/12	REVUE 65	VENUS 157	SIGMA
SINDACO	SONCEBOZ 113 LEP.	TISSOT 38.2	UNITAS 85	UNITAS 87	UNITAS 88	UNITAS 211	UNITAS 285

**VERKSÖKARE****RUNDA VERK MED STENANKARE****WERKSUCHER****RUNDE WERKE MIT STEINANKERN**

	<b>UNITAS 411</b>	<b>UNITAS 493</b>	<b>UNITAS 498</b>	<b>ZENITH 173</b>	<b>ZENITH 177</b>		
	<b>EBEL 14/12</b>	<b>L.L.</b>	<b>LANCO 1721</b>	<b>LANCO 1737</b>	<b>OMEGA 130 CHR</b>	<b>RECORD 53</b>	
	<b>BUREN 30</b>	<b>CORTEBERT 522</b>	<b>UNITAS 311</b>	<b>UNITAS 343</b>	<b>UNIVERSAL 290</b>		
	<b>AM 196</b>	<b>AS 233</b>	<b>AUBETTE 22</b>	<b>BUREN 70</b>	<b>CORTEBERT 530, 532</b>	<b>CORTEBERT 474</b>	
	<b>ETERNA 403</b>	<b>ETERNA 467</b>	<b>F.E.S. 22/12</b>	<b>FELSA 180, 283</b>	<b>FELSA 182, 183</b>	<b>HELVETIA PARADOX</b>	
<b>HELVETIA 38</b>	<b>H.P. 40</b>	<b>I.W.C. 67</b>	<b>LANCO 467</b>	<b>LA 22/12 ROCHETTE</b>	<b>LIENGME 30/12</b>	<b>MONTILIER 66</b>	<b>MONTILIER 68</b>
<b>MOVADO 300</b>	<b>MST 158</b>	<b>MST 238</b>	<b>MST 407</b>	<b>MST 408</b>	<b>NAPOLEON</b>	<b>H.P. 27</b>	<b>PHENIX 400, 785, 900 24/12</b>
<b>PHENIX 432, 781 30/12</b>	<b>PHENIX 783 22/12</b>	<b>PHENIX 775 24/12</b>	<b>RECORD 31</b>	<b>RECORD 33</b>	<b>RECONVILIER 26, 222</b>	<b>SONCEBOZ 21/12</b>	<b>UNITAS 82</b>
<b>ULTRA 41</b>							



**VERKSÖKARE**

RUNDA VERK MED STENANKARE

**WERKSUCHER**

RUNDE WERKE MIT STEINANKERN



	ALPINA 273	AM 75	AM 206	AS 746	DOXA 21/1	F.E.S. 411	
	HELVETIA 30 H 3,6	HELVETIA 31 H 4,2	HELVETIA 32 H 4,8	HELVETIA 33 H 5,3	LONGINES 19.90 N	MONTILIER 65	
ORATOR 220 24/12	REVUE 30 LEP	REVUE 30 SAV	REVUE 51,53 LEP	REVUE 51, 53 SAV	SONCEBOZ 99	SONCEBOZ 300	UNITAS 25 H 5,20
UNITAS 31 H 5,30	UNITAS 33 H 4,15	UNITAS 231 H 5,30	UNITAS 233 H 4,20	UNITAS 359 H 6,50	UNITAS 361 H 4,70	UNITAS 419 H 4,10	UNITAS 429 H 6,50
UNITAS 431 H 4,70	ZENITH 18-28/3A	ZENITH 18-28-3 P	ZENITH 18-28-1 T/3 T 19-28-1 T	ZENITH 18-28-2 T/4 T 19-28-2 T	ZENITH 18 1/2 NVS 19 BAS VS		
	AS 213	AS 378	AS 690	BUREN 690	BUSER 95	CORTEBERT 528	
	CYMA	CYMA 915	CYMA 918	DAMAS N.G.	DAMAS 9	DOXA 30/12	
ELECTION 47	ETERNA 62	ETERNA 163	ETERNA 320 SAV	ETERNA 321 LEP	ETERNA 431	ETERNA 433	ETERNA 805
FEF 20	FEF 40 B H 4,2	FEF 40 H H 5,3	FEF 41 B H 4,2	FEF 41 H H 5,3	FHF 1,3,2124 H 5,25	FHF 2144	FHF 3154







**VERKSÖKARE**

RUNDA VERK MED STENANKARE

**WERKSUCHER**

RUNDE WERKE MIT STEINANKERN

 19'''							
							
							
							
							
							
							

20'''		20 1/2'''	24'''			26'''
						
ETERNA 435	ETERNA 485	ZENITH NVS LEP	DOXA	ETERNA 490	MALLERAY 40	OMEGA 59.80



**VERKSÖKARE**  
FORMVERK MED STENANKARE







**WERKSUCHER**  
FORM WERKE MIT STEINANKERN

 3 1/4 × 10'''	 ETA 610			 4 1/4 × 11 1/4'''	 BLANCPAIN 56		
 3 3/4 × 9 1/2'''	 CERTINA 200			 4 1/2 × 11'''	 AS 748		
 3 3/4 × 10'''	 CHEZARD 30	 FHF 59/59N	 PRECIMAX 105	 4 2/3 × 11'''	 AURORE 17	 CHEZARD 40	 FHF 52
 4 × 6'''	 EBEL 40	 FEF 160	 FEF 166	 MST 315			
 ROLEX 90				 4 3/4 × 6 1/2'''	 AS 1017	 EBEL 47	
 4 × 7'''	 AS 545			 4 3/4 × 6 3/4'''	 CYMA 433		
 4 × 8'''	 ETA 775	 ETERNA 780	 ETA 830	 4 3/4 × 8'''	 ALTUS 7	 SONCEBOZ 253	
 UNIVERSAL 207				 4 3/4 × 10'''	 ALPINA 445	 ALPINA 455	 PESEUX 10-11
 4 1/4 × 10'''	 CYMA 354	 ETA 650 651 653	 ETA 660	 4 3/4 × 10 1/2'''	 FRECO FREY G		
 ETA 745	 ETA 746	 GRUEN 520	 PESEUX 130	 4 3/4 × 11'''	 ET 475	 ETA 705	 ETA 750
 4 1/4 × 10 3/4'''	 FRECO FREY J	 FELSA 280	 PESEUX 90	 4 3/4 × 11 1/2'''	 AS 808		
 4 1/4 × 11'''	 ROLEX 170						



**VERKSÖKARE**  
FORMVERK MED STENANKARE

**WERKSUCHER**  
FORMWERKE MIT STEINANKERN

 5 × 6 1/2'''	 ROLEX 100 150	 ROLEX 160-161		 5 × 8 3/4'''	 CYMA 050	 CERTINA 145	 ETERNA 460
 5 × 6 3/4'''	 JUNGHANS J 79	 TISSOT 11.6	 TISSOT 11.7	 5 1/4 × 6 3/4'''	 TISSOT 11.7		
 5 × 7'''	 ALPINA 447	 ALPINA 459	 AS 976	 5 1/4 × 7'''	 FHF 130	 H.B. 675 alt	 H.B. 675 neu
 AS 1234	 BAUER 500	 BIFORA 49	 CORTEBERT 650	 5 1/4 × 8'''	 BAUER 25	 BAUER 525	 BIFORA 50
 CERTINA 12-10	 DOXA 12	 DUROWE 753	 EBEL 50	 BIFORA 55	 DAMA 50	 DUROWE 56, 59	 DUROWE 58
 ELECTION 275	 ENICAR 680	 ENICAR 976	 FEF 430	 ETA 2340 2350	 ETA 2345	 ETERNA 1404	 FÖRSTER 60
 GUBA 500	 LANCO 506	 LIP T 124	 MARVIN 160	 FÖRSTER 611	 FÖRSTER 630	 GUBA 25	 KASPER 400, 600
 MOVADO 65	 OMEGA 210	 PESEUX 140	 PESEUX 290	 LANCO 576	 LANCO 5106	 LIENGME 152	 VUFE 57/5
 PIERCE 516	 PRECIMAX 115	 P.U.W. 70	 RECTA N	 VUFE 57/6	 ZARIA 1800	 ZARIA 1801	
 REVUE	 REVUE 48	 ROLEX TUDOR 1057	 TUDOR 434	 5 1/4 × 8 1/4'''	 AS 846	 H.P. 25	
 UNIVERSAL 219	 UNIVERSAL 500	 VUFE 57/4	 ZENITH 57.8 57	 5 1/4 × 8 1/2'''	 ALPINA 465	 ALPINA 466	 A.H.O. 555
 5 × 8 1/2'''	 ETA 540	 M. S. T. 281	 MST 284	 AM 65	 AM 115	 AS 475	 AS 655



**VERKSÖKARE**  
FORMVERK MED STENANKARE

**WERKSUCHER**  
FORMWERKE MIT STEINANKERN

5 1/4 x 8 1/2'''

AS 1051	ASTOR	A.V. 10	A.V. 41	BLANCPAIN 46	BUREN 35	BUSER 5	
CERTINA 83	CERTINA 88	CERTINA 89	CERTINA 230	CHEZARD 50	CORTEBERT 635	DAMA 45	DAMA 110
DAMA 112	DAMA 514A	DAMAS 90	DERBY 125	DERBY 127	DOXA 14	DUROWE 50	DUROWE 55
EBEL 53	EBEL 54	ET 525	ET 527	ELECTION 215	ENICAR 141	ESSOR 9	ETA 370
ETA 761 1201	ETA 1150	ETERNA 616	ETERNA 1057	FEF 110	FEF 270	FELSA 302	FELSA 800
FELSA 4045	FHF 75	FHF 80 190	FRECO FREY L	G.H. 33	GRUEN 107	HELVETIA 105, 106	HORA
H.S. 514	J.E.J. 24	J.E.J. 200	KUMMER 270	KURTZ 12.121	LANCO 520	LANCO 522	LANCO 5159
LAVINA 140	LUNESA 25	MARVIN 100	MARVIN 140	MELANO 109	MEYER&SES FILS 70	MOERIS 39	M. P. 10
MST 313	M.S.T. 349	OSCO 53.70	OTERO 25	PESEUX 100	PESEUX 120	PESEUX 280	PHENIX 514
PIERCE 59	PRECIMAX 110	PRECIMAX 500	P.U.W. 49	P.U.W. 600 alt	RECONVILIER 11	RECTA H	RECORD 108.109
REVUE 55	REVUE 61	REVUE 85	S.F.H	T.E.S. 54	TUDOR 1151	UNITAS 510	UNITAS 520 521
UNITAS 525	UNITAS 530	UNIVERSAL 220	UROFA 542	VENUS 55	WILKA 322	VULCAIN 142/143	ZENITH 525



**VERKSÖKARE**  
FORMVERK MED STENANKARE

**WERKSUCHER**  
FORMWERKE MIT STEINANKERN

 5 1/4 × 8 3/4'''	 LANCO 524	 OTERO 56	 V.C. 55	 5 1/2 × 6 3/4'''	 TISSOT 712		
 V.C. 110	 V.C. 120			 5 1/2 × 7'''	 AS 1491	 DUROWE 70, 71	 ETERNA 880
 5 1/4 × 9 1/2'''	 ROLEX 180			 ESSOR 1322	 GENEVA SPORT 60	 HELVETIA 120	 PESEUX 340
 5 1/4 × 10'''	 AM 90	 AS 1037		 SEIKO SOLAR			
 5 1/4 × 10 1/4'''	 AV 9			 5 1/2 × 8 1/2'''	 OMEGA 12.6	 OMEGA T 12.6	 PESEUX 50
 5 1/2 × 6 1/2'''	 EBEL 56	 ETA 2480/2482	 P.U.W. 73	 RECORD STABILIS			
 UNIVERSAL 580	 ZARIA 1509 SC			 5 1/2 × 9'''	 ASTER 22/13		
 5 1/2 × 6 3/4'''	 AS 1012	 BIFORA 51	 BULOVA 5 AH	 5 1/2 × 9 1/2'''	 LIP T 12	 TISSOT 12.6	
 BULOVA 5 AD	 BUREN 60	 CERTINA 13-10	 CERTINA 13-20	 5 1/2 × 9 3/4'''	 BLANCPAIN 52		
 EBEL 55	 ETA 875	 FEF 6600	 KASPER 1100	 5 1/2 × 10'''	 AM 56	 ELECTION 70	 FHF 9244
 LANCO 558	 LANCO 559	 MST 366	 OMEGA 480	 FRECO FREY 55 F			
 REVUE 88	 REVUE 205	 T.E.S. 73	 TISSOT 12.9-E9	 5 1/2 × 10'''	 AS 610	 FHF 9344	 SIGMA O-D



**VERKSÖKARE**  
FORMVERK MED STENANKARE











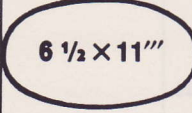



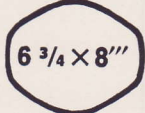









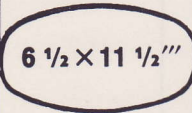







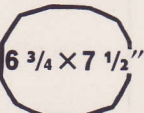





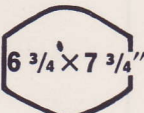











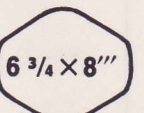



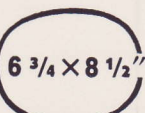







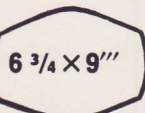





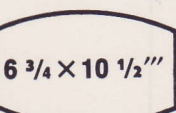







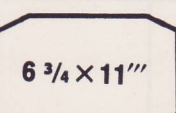







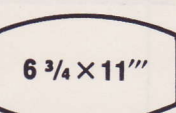

**WERKSUCHER**  
FORMWERKE MIT STEINANKERN

 5 1/2 × 11 1/2'''	 CYMA 344			 6 × 7 3/4'''	 OMEGA 240	 OMEGA 244	
 5 3/4 × 6 3/4'''	 LONGINES 13.15/13.15 V			 6 × 10'''	 AS 442	 ETERNA 345	 FEF 150
 5 3/4 × 7'''	 DOXA 14	 EBEL 57	 EBEL 58	 6 1/4 × 7 1/2'''	 UNIVERSAL 217		
 5 3/4 × 7'''	 ETA 1045	 ETA 1185	 ETERNA 1050	 6 1/4 × 7 3/4'''	 MOVADO 25		
 ETERNA 1187	 FELSA 370	 TISSOT 13.6	 TISSOT 13.6 1 T	 6 1/4 × 10'''	 GLYCINE 13		
 5 3/4 × 7 1/4'''	 HELVETIA 110,111	 GP 73		 6 1/2 × 10'''	 FELSA 60		
 5 3/4 × 8 1/2'''	 LONGINES 12.19			 6 1/2 × 10 1/2'''	 LONGINES 8.47		
 5 3/4 × 8 3/4'''	 JUNGHANS J 78			 6 1/2 × 11'''	 ALTUS 4	 AM 80	 AS 628
 5 3/4 × 9'''	 JAEGER-LE COULTRE 407			 AV 8	 BLANCPAIN 49	 CERTINA 175	 ETA 425
 5 3/4 × 10 1/2'''	 ROLEX 250			 FELSA 128	 FELSA 176	 FRECO FREY 60 R	 FRECO FREY 61 T
 6 × 7'''	 SLAVA 1600	 SLAVA 1601		 MEYER & SES FILS 65	 OMEGA 14.8F	 PESEUX 24, 25	 RUSSBACH- HANNI 2
 6 × 7 1/2'''	 AS 1186			 SONCEBOZ 246	 SONCEBOZ 250	 VENUS 51. 52	 WASA 110



**VERKSÖKARE**  
FORMVERK MED STENANKARE

**WERKSUCHER**  
FORMWERKE MIT STEINANKERN

 6 1/2 x 11'''	 AS 500	 ASTER 25/14	 FELSA 66	 6 3/4 x 8'''	 HELVETIA 95	 JUNGHANS J 71	 JUNGHANS J 73
 FHF 9254	 V.C. 148			 LANCO 642	 LONGINES 14.16/14/16S	 LONGINES 15.18/1518S	 MST 381
 6 1/2 x 11 1/2'''	 BLANCPAIN 50	 BUREN L.N.	 CERTINA 74	 MST 440	 OSCO 72	 OTERO 137, 1371 CLD	 PIERCE 608 D
 6 3/4 x 7 1/2'''	 AS 1138	 REVUE F1		 P.U.W. 80	 RECORD 75	 ROLEX 1300	 SEIKO SPORT LADY
 6 3/4 x 7 3/4'''	 AS 1023	 GP 68	 GRUEN 210	 ST 69	 T.E.S. 60	 TISSOT 15.3/15.3.2	 UNITAS 190
 GRUEN 215	 GRUEN 270	 LONGINES 14,17		 UNITAS 540			
 6 3/4 x 8'''	 A.H.O. 675	 A.V. 46	 A.V. 122	 6 3/4 x 8 1/2'''	 AS 1111	 AS 1299	 JUNGHANS J 99, J 99/1
 BERGER	 BUREN 55	 BUSER 681	 BIFORA 68	 6 3/4 x 9'''	 DAMA 65	 LIP T 15	
 CERTINA 15-10	 CERTINA 257	 CORTEBERT 686	 CYMA 384	 6 3/4 x 10 1/2'''	 ETA 411	 ETA 765	 SONCEBOZ 257
 DERBY 67	 DUROWE 61	 EBEL 68	 FEF 360	 6 3/4 x 11'''	 ALPINA 861	 AM 105	 AS 368, 417 427, 428, 441
 FEF 370, 371	 FHF 60 601 SC	 FHF 61	 FHF 62	 6 3/4 x 11'''	 AS 525, 588	 AS 724	 AS 962
 FHF 69	 FHF 120 212 SC	 FHF 123	 H.B. 80	 AS 1306	 ASTER	 BUREN 675	 CHEZARD 60





**VERKSÖKARE**  
FORMVERK MED STENANKARE

**WERKSUCHER**  
FORMWERKE MIT STEINANKERN

 6 3/4 × 11'''	 CYMA 063. 067	 DAMAS 80	 DERBY 36	 7 3/4 × 10 1/2'''	 ENICAR 960		
 6 3/4 × 11'''	 ESSOR 214	 ETERNA 350	 ETERNA 770	 7 3/4 × 11'''	 ALPINA 475	 ALPINA 777	 AM 350
 FELSA 157	 FELSA 187	 FHF 56	 FHF 85	 BIFORA 711	 BULOVA 7 AP	 BUSER 80	 BUREN 50
 F.H.F. 8244	 F.H.F. 8344	 LANCO 1	 LANCO 622	 CERTINA 251	 CORTEBERT 640	 CYMA 364	 DAMA 150
 MARVIN 200	 MARVIN 210	 MST 237	 MST 327	 DUROWE 275	 DOXA ref. 6413	 EBEL 711	 ETA 734, 735, 736, 757
 PESEUX 30, 38	 ROLEX 200/210			 ETERNA 740 758	 FAVOR 250	 FEF 130	 GRUEN 311
 6 3/4 × 13'''		 A.V. 14T		 LANCO 722	 LONGINES 9 LT	 MARVIN 640	 MST 348
 7 × 8'''	 BENRUS B.P./1250	 ETA 1240	 ETERNA 1244	 OMEGA T 17	 RECORD 116 117	 REVUE 70	 REVUE 73
 7 1/4 × 9 3/4'''	 UNIVERSAL 239			 REVUE 84	 VULCAIN 105		
 7 1/2 × 14 1/2'''		 ROLEX 300,350		 7 3/4 × 11 3/4'''		 MST 310	
 7 3/4 × 9'''	 FRECO FREY H			 7 3/4 × 11 1/4'''		 LONGINES 25.17	 LONGINES 25.17 ABC
 7 3/4 × 9 1/2'''	 OMEGA 17.2	 OMEGA 300	 TISSOT 17.5	 7 3/4 × 12'''		 A.V. 18	











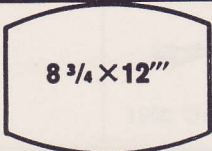











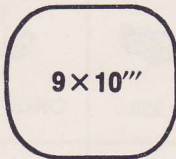

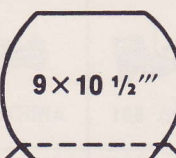

**VERKSÖKARE****FORMVERK MED STENANKARE****WERKSUCHER****FORMWERKE MIT STEINANKERN**

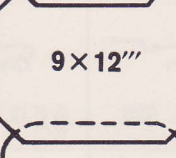
	 LIP T 18				 ALPINA 490		
	 CYMA 404	 EBEL 80	 ETA 865		 CYMA 334		
 ETA 1000	 ETA 1090	 ETA 1220	 ETERNA 1005		 VUFE 57/12		
 F.E.F. 170	 UNIVERSAL 232				 ALPINA 847	 AS 954	
	 FHF 155	 PESEUX 160-2	 ZENITH 810	 BIFORA 812	 BIFORA 2025	 BIFORA 2030	 BIGALU 111
		 A.V. 19	 MARVIN 610	 BUREN 14	 BUSER 50	 CERTINA 190	 DAMAS 40
		 JAEGER LE COULTRE 438	 MARVIN 600	 ELECTION 610	 ESSOR	 ETA 715	 ETERNA 710
		 AS 1045		 FHF 29,53	 F.H.F. 8044, 8444	 FRECO FREY M	 FÖRSTER 2075
		 A.S. 552	 A.S. 872	 GLYCINE 81	 GRUEN 325	 HANHART	 HANHART 36
	 LONGINES 21.19			 HELVETIA 75	 JUNGHANS J 86	 JUNGHANS J 98	 LANCO 826
	 GRUEN 430			 LAVINA 125	 LOCARNO	 MAUTHE 1001,1003	 MELANO 110
	 GRUEN 370			 MOERIS 20, 26 T	 MST 346	 OMEGA 20 F	 OSCO 42

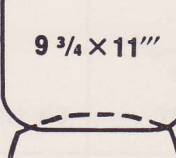

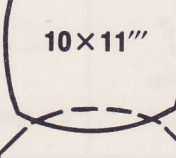
**VERKSÖKARE**  
**FORMVERK MED STENANKARE**

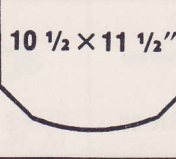
**WERKSUCHER**  
**FORMWERKE MIT STEINANKERN**

 8 3/4 × 12'''		 PESEUX 110	 PHENIX 837
 P.U.W. 500	 P.U.W. 501	 RECORD 110, 112	 RECTA 820 T
 REVUE 71	 TISSOT 20	 UNIVERSAL 240	 VENUS 130
 ZENITH F			
 9 × 10'''		 AS 1280	 AS 1300
		 GP 91	
 9 × 10 1/2'''		 PESEUX 250	
 9 × 12'''		 REVUE 54	
 9 3/4 × 11'''		 FELSA 275	
 10 × 11'''		 GRUEN 405, 406	
 10 1/2 × 11 1/2'''		 AS 1104	

**ATT BESTÄLLA PÅ RÄTT SÄTT**

spar tid och obehag.

**ANGIV ALLTID**

1. Urdelens rätta benämning och om möjligt nr enl. EBAUCHES ordlista
2. Verkets fabrikat (namnet på urtavlan är ej alltid tillräckligt)
3. Verkstorlek
4. Kaliberbeteckning — det finns vanligen
  - a) på verkets tavel sida
  - b) i balansens närhet
  - c) på fjäderhusbryggan
5. Kan dessa uppgifter ej lämnas, sänd in prov på delen och bifoga verket. Sänd ej kompletta ur, utan endast verket med avtagen urtavla.

**BALANSAXLAR**

Uppgiv!

1. Verket är utan stötsäkring
2. Verket är med stötsäkring Incabloc, Sh. Res., KIF, Rufarex etc.

**KOMPLETTA BALANSER**

Uppgiv!

1. Verket är utan stötsäkring
2. Verket är med stötsäkring Incabloc, Sh. Res., KIF, Rufarex etc.

**ANKARE — ANKARHJUL — SEKUNDHJUL —  
TRANSPORHJUL**

Uppgiv!

Verket är:

1. utan motstenar
2. med motsten över (verksida)
3. med motsten under (tavelsida)
4. med 2 motstenar

**MINUTRÖR — TIMHJUL — CENTRUMSEKUND-  
DRIV — CENTRUMSEKUNDHJUL**

Angiv totalhöjd i 1/100 mm

**AUF DIE RICHTIGE WEISE BESTELLEN**

erspart Zeit und Unbehagen.

**BITTE IMMER ANGEBEN**

1. Die richtige Bezeichnung des Uhrenteiles und wenn möglich die Nr lt. EBAUCHES Wörterliste
2. Fabrikat des Werkes (der Name auf dem Zifferblatt ist nicht immer ausreichend)
3. Werkgröße
4. Kaliberbezeichnung — meistens zu finden
  - a) auf der Zifferblattseite des Werkes
  - b) in der Nähe der Unruhe
  - c) auf der Federhausbrücke
5. Können diese Angaben nicht geliefert werden, bitte Probe des Teiles einsenden und Werk beifügen.  
Keine kompl. Uhren einsenden, sondern nur das Werk mit abgenommenem Zifferblatt.

**UNRUHWELLEN**

Bitte angeben!

1. Das Werk ist ohne Stossicherung
2. Das Werk ist mit Stossicherung Incabloc, Sh. Res., KIF, Rufarex etc.

**KOMPLETTE UNRUHEN**

Bitte angeben!

1. Das Werk ist ohne Stossicherung
2. Das Werk ist mit Stossicherung Incabloc, Sh. Res., KIF, Rufarex etc.

**ANKER — ANKERRAD — SEKUNDENRAD KLEIN-  
BODENRAD**

Bitte angeben!

Das Werk ist:

1. ohne Decksteine
2. mit Deckstein oben (Werkseite)
3. mit Deckstein unten (Zifferblattseite)
4. mit 2 Decksteinen

**MINUTENROHR — STUNDENRAD — ZENTRUM-  
SEKUNDENTRIEB — ZENTRUMSEKUNDENRAD**

Bitte Totalhöhe in 1/100 mm angeben.